

2022 Catalogue

..... Toilet Collection



Toilet Warranty Guide

Poseidon Building Supplies PTY. LTD. T/A Poseidon Bathroom and Kitchen will supply supportive after sale services to our merchants and end users.

It is the responsibility of you and installer before installation to ensure the goods are correct and free of obvious visible faults. The toilet needs to be tested for water leaking before full installation.

Any approved warranty claims will include first year labor. Warranty policies for toilet are set out as below:

Warranty Policies for **Domestic Use:**

10 Years Replacement on Ceramic (pans and Cisterns) 1 year labour
1 Year Replacement on Parts which include toilet seat covers, flush pipes and buttons
2 Years Replacement on inlet or outlet valves
1 Year Replacement on Parts of Accessories

Warranty Policies for **Commercial or Public Use:**

3 Years Replacement on Ceramic (pans and Cisterns) 1 year labour
1 Year Replacement on Parts which include toilet seat covers, flush pipes and buttons
1 Year Replacement on inlet or outlet valves
1 Year Replacement on Parts of Accessories

All Warranty claims must be in writing to Service@poseidonbk.com.au and may require photos if requested, along with proof of purchase.

Poseidon Bathroom and Kitchen will not accept claims against this warranty where the following conditions are found to exist:

- Plumbing installations have not been carried out by a licensed plumber, and/or are not in accordance with the Plumbing Code of Australia AS3500 and ABCB guidelines. (Relevant codes or regulations set by the various States or Territories)
- The goods have been installed by a licensed Plumber but not installed correctly.
- The goods have been installed correctly by a licensed Plumber, however subsequent repairs, modifications and/or adjustments to the goods after installation have not been carried out by a licensed plumber.
- Claims against faulty cistern valves, and seals will be rejected where after-market sanitizing additives have been introduced into the toilet cistern tanks, rather than to the toilet bowls.
- Claims for visual defects to product surfaces may be rejected where harsh cleaning or scouring products have been used.
- Claims against vitreous china product, inaccurate dimensions, or glazing imperfections (That are permitted within AS1976-1992 Vitreous China used in Sanitary Applications). It is permitted that vitreous china products can vary up to +/- 5mm on any surface and be acceptable products due to the unique conditions of the product's manufacturing process.

Site Calls

Where Poseidon Bathroom and Kitchen has arranged a site-call, and a claim is rejected following inspection (often in the case of unlicensed or incorrect installation), the consumer will be charged a call-out fee of \$120+GST, plus \$70.00 per hour labour charge, including any additional travel time should parts be required, payable to Poseidon Bathroom and Kitchen.

Water Damage

Some claims may include a claim for rectification of water damage to surrounding areas as a result of leaking from a product. Such claims will require a site-call by a Poseidon Bathroom and Kitchen representative who will evaluate the claim. A further inspection by an insurance representative may also be required before a claim can be determined.

Warranty Limitations

To the extent permitted under the Australian Consumer Law, and other relevant legislation, it is the responsibility of you and installer before installation to ensure the goods are correct and free of obvious visible faults. Poseidon Bathroom and Kitchen's liability is limited in the following circumstances:

- Poseidon Bathroom and Kitchen are not responsible for any lack of operation or performance of goods (or any loss or damage) where the goods have been subject to misuse, negligence, accident or are used or adapted for a purpose for which they were not designed.
- Poseidon Bathroom and Kitchen are not responsible for the labor and rectification costs incurred in the above circumstance.

Except as expressly stated, and to the extent permitted by law, this warranty does not include any right to be reimbursed or compensated for physical or financial injury, loss, damage, expense, time, inconvenience (whether direct or indirect) or special losses arising out of the occurrence of a defect in the parts or products or caused by use or installation of the products or damages caused by acts of nature.





Rimless

**Avis
KDK022R**

655*385*870mm

Ma e Black: **KDK022R-MB**
Ma e White: **KDK022R-MW**



Rimless

**Avis Compact
KDK600**

605*380*870mm



Rimless

**Livis
KDK022**

650*390*865mm



Tornado

**Veda
KDK025**

630*380*835mm

Gloss Black: **KDK025-B**



Tornado

**Vivid
KDK026**

655*385*870mm



Skew

**Bela
KDK018**

665*375*830mm



Box Rim

**Rola Short Projection
KDK023**

635*380*830mm



Box Rim

**Avery
KDK002**

710*390*830mm

Gloss Black: **KDK002-B**



Box Rim

**Qubist
KDK003**

665*380*845mm

Gloss Black: **KDK003-B**





Box Rim

**Kasey
KDK008**

695*390*830mm
Gloss Black: **KDK008-B**



Box Rim

**Pola
KDK005**

675*395*840mm



Box Rim

**Mercury
KDK014**

665*375*810mm



Box Rim

**Rio
KDK013**

635*375*810mm



Box Rim

**Theo
KDK016**

660*375*845mm



Box Rim

**Cubo
KDK006**

655*380*800mm



Box Rim

**Zion
KDK009S**

630*350*805mm



**Avery
KDK202**

590*365*410mm



**Qubist
KDK203**

595*355*410mm



**Veda
KDK205**

590*360*410mm

Rimless



Avis
KDK102R

575*360*415mm

Ma e Black: **KDK102R-MB**
Ma e White: **KDK102R-MW**

Rimless



Elvera
KDK107R

585*360*455mm

Tornado



Veda
KDK105T

595*360*410mm
Gloss Black: **KDK105T-B**

Box Rim



Avery
KDK102

595*360*415mm
Gloss Black: **KDK102-B**

Box Rim



Qubist
KDK103

595*345*410mm
Gloss Black: **KDK103-B**

Wall Hung Pan

Rimless



Avis
KDK302R

520*360*325mm

Ma e Black: **KDK302R-MB**
Ma e White: **KDK302R-MW**

Rimless



Veda
KDK305R

550*360*330mm

Box Rim



Avery
KDK302

555*360*320mm
Gloss Black: **KDK302-B**

Box Rim



Qubist
KDK303

550*340*320mm
Gloss Black: **KDK303-B**





Box Rim



**Amber
KDK019**

630*350*875mm



Box Rim



**Ambulant Box Rim
KDK021**

660*400*905mm



Tornado



**Elvera Ambulant
KDK027**

650*385*870mm



Box Rim



**Calla
KDK024**

820*350*1180mm



im



**Calla P-Trap
KDK029**

820*350*1180mm



Rimless



**Asta
KDK800**

805*375*890mm



Tornado



**Asta Care
KDK106**

800*360*430mm



Rimless



**Avis Extra Height
KDK102HR**

620*360*440mm



Tornado



**Elvera
KDK107T**

630*365*445mm



Rimless



**Avis Junior
KDK600J**

600*340*770mm



Rimless Toilet Suite

Avis Rimless Toilet Suite KDK022R Gloss White: \$660 Matte Black: \$924 Matte White: \$924



Back/Left and Right Bottom Inlet Cistern (KDK022RC)
Rimless Flush Pan (KDK022RP)

Features

Easy Height

4.5/3 Liters Dual Flush
Size: **655*385*870mm**
Trap-100: 100-165mm (Supplied)
UF Slim Seat SC1064 (Supplied)

Optional

Trap-60: 60-110mm
JT43: 150-205mm
P-Trap: 180mm
UF Thick Seat SC804/UF Slim Seat SC805
Geberit Cistern: KDK022RC-G

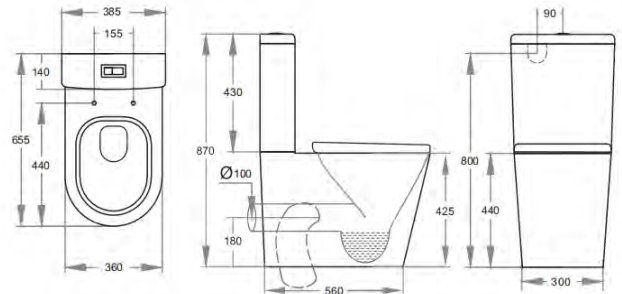

Avis Compact Rimless Toilet Suite KDK600

\$660



Back/Left and Right Bottom Inlet Cistern (KDK600C)
Rimless Flush Pan (KDK600P)

Features

Compact Easy Height

4.5/3 Liters Dual Flush
Size: **605*380*870mm**
Trap-100: 100-145mm (Supplied)
UF Slim Seat SC1064 (Supplied)

Optional

Trap-60: 60-95mm
JT43: 150-185mm
P-Trap: 180mm
UF Thick Seat SC804/UF Slim Seat SC805
Geberit Cistern: KDK600C-G

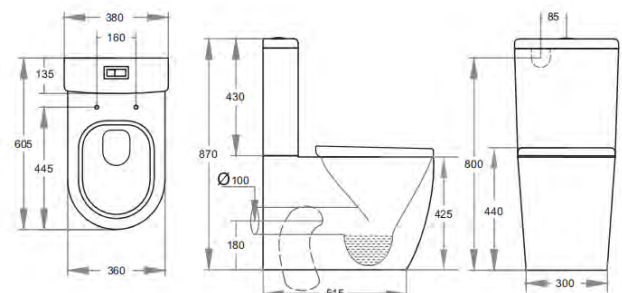

Livis Rimless Toilet Suite KDK022

\$495



Back/Left and Right Bottom Inlet Cistern (KDK022C)
Rimless Flush Pan (KDK022P)

Features

Easy Height

4.5/3 Liters Dual Flush
Size: **650*390*865mm**
Trap-100: 100-170mm (Supplied)
UF Slim Seat SC1064 (Supplied)

Optional

Trap-60: 60-120mm
JT43: 150-210mm
P-Trap: 180mm
UF Thick Seat SC804/UF Slim Seat SC805

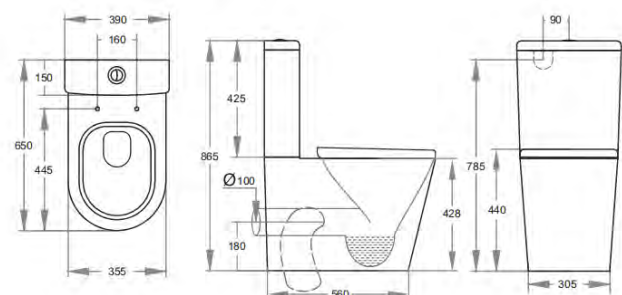

Tornado Toilet Suite

Veda BTW Toilet Suite KDK025

Gloss White: \$495 Gloss Black: \$825



Back/Left and Right Bottom Inlet Cistern (KDK025C)
Tornado Flush Pan (KDK025P)

Features

4.5/3 Liters Dual Flush
Size: **630*380*835mm**
Trap-100: 100-145mm (Supplied)
UF Slim Seat SC805 (Supplied)

Optional

Trap-60: 60-95mm
JT43: 150-185mm
P-Trap: 180mm
UF Thick Seat SC804
Geberit Cistern: KDK025C-G

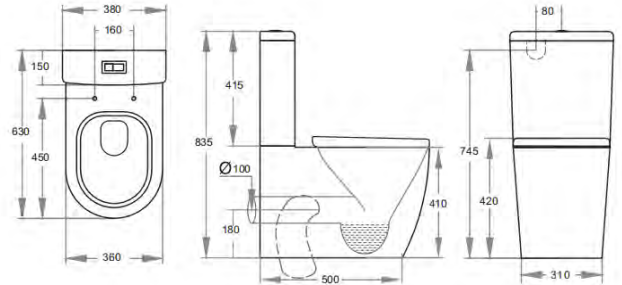

Vivid BTW Toilet Suite KDK026

\$495



Back/Left and Right Bottom Inlet Cistern (KDK026C)
Tornado Flush Pan (KDK026P)

Features

4.5/3 Liters Dual Flush
Size: **655*385*870mm**
Trap-100: 100-150mm (Supplied)
UF Slim Seat SC1064 (Supplied)

Optional

Trap-60: 60-100mm
JT43: 150-200mm
P-Trap: 180mm
UF Thick Seat SC803 Geberit
Cistern: KDK026C-G

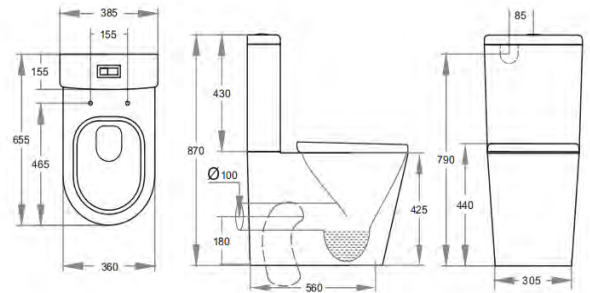

Skew Toilet Suite

Bela Skew Toilet Suite KDK018

\$770



Back/Left and Right Bottom Inlet Cistern (KDK018C)
Box Rim Pan (KDK018P)

Features

4.5/3 Liters Dual Flush
Available in both right and left Traps
Size: **665*375*830mm**
Skew Trap (Supplied)
UF Standard Seat SC804 (Supplied)

Optional

Trap-60: 60-150mm
Trap-100: 100-230mm
JT-43: 150-270mm
UF Slim Seat SC805

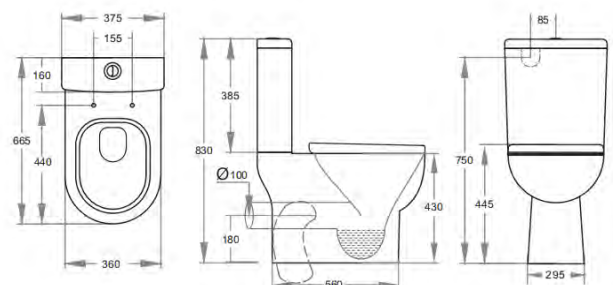

Box Rim Toilet Suite

Rola Short Projection Toilet Suite KDK023

\$440



Back/Left and Right Bottom Inlet Cistern (KDK023C)
Box Rim Pan (KDK023P)



Features

4.5/3 Liters Dual Flush
Size: **635*380*830mm**
Trap-100: 100-160mm (Supplied)
UF Standard Seat SC804 (Supplied)

Optional

Trap-60: 60-115mm
JT43: 150-195mm
P-Trap: 180mm
UF Slim Seat SC805

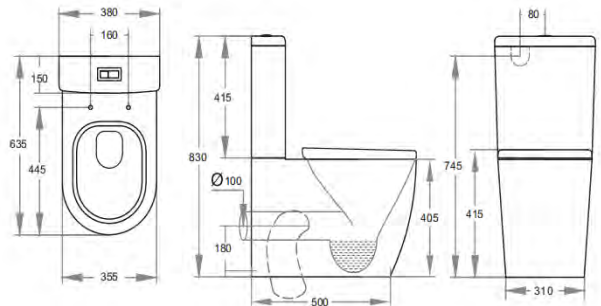

Avery BTW Toilet Suite KDK002

Gloss White: \$440 Gloss Black: \$770



Back/Left and Right Bottom Inlet Cistern (KDK002C)
Box Rim Pan (KDK002P)



Features

4.5/3 Liters Dual Flush
Size: **710*390*830mm**
Trap-60: 60-160mm (Supplied)
UF Standard Seat SC803 (Supplied)

Optional

Trap-100: 100-215mm
JT43: 150-255mm
P-Trap: 180mm
UF Slim Seat SC1064
Geberit Cistern: KDK002C-G

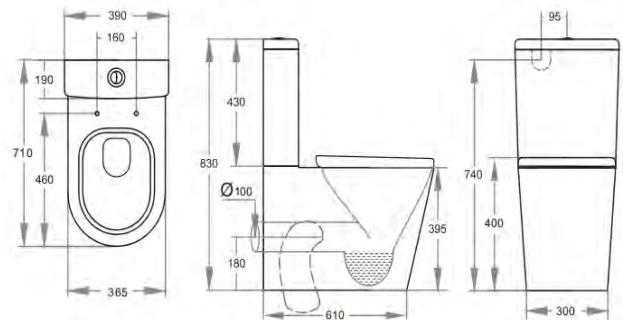

Qubist BTW Toilet Suite KDK003

Gloss White: \$440 Gloss Black: \$770



Back/Left and Right Bottom Inlet Cistern (KDK003C)
Box Rim Pan (KDK003P)



White: With Square Press Button
Black: With Round Press Button

Features

Black and White colors
4.5/3 Liters Dual Flush
Size: **665*380*845mm**
Trap-60: 60-150mm (Supplied)
UF Standard Seat SC802 (Supplied)

Optional

Trap-100: 100-205mm
JT43: 150-240mm
P-Trap: 180mm
Geberit Cistern: KDK003C-G

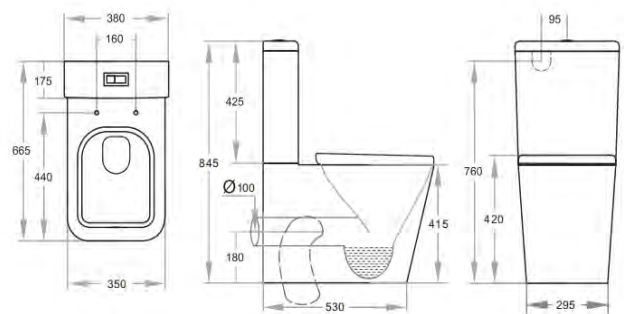

Box Rim Toilet Suite

Kasey BTW Toilet Suite KDK008

White: \$440 Black: \$770



Back/Left and Right Bottom Inlet Cistern (KDK008C)
Box Rim Pan (KDK008P)

Features

Black and White Colors

4.5/3 Liters Dual Flush

Size: **695*390*830mm**

Trap-60: 60-160mm (Supplied)

UF Standard Seat SC803 (Supplied)

Optional

Trap-100: 100-215mm JT43:

150-250mm

P-Trap: 180mm

UF Slim Seat SC1064 Geberit

Cistern: KDK008C-G

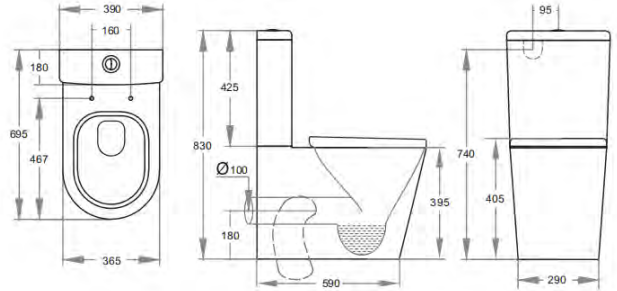

Pola BTW Toilet Suite KDK005

\$396



Back/Left and Right Bottom Inlet Cistern (KDK005C)
Box Rim Pan (KDK005P)

Features

4.5/3 Liters Dual Flush

Size: **675*395*840mm**

Trap-60: 60-160mm (Supplied)

UF Standard Seat SC803 (Supplied)

Optional

Trap-100: 100-215mm

JT43: 150-250mm

P-Trap: 180mm

UF Slim Seat SC1064

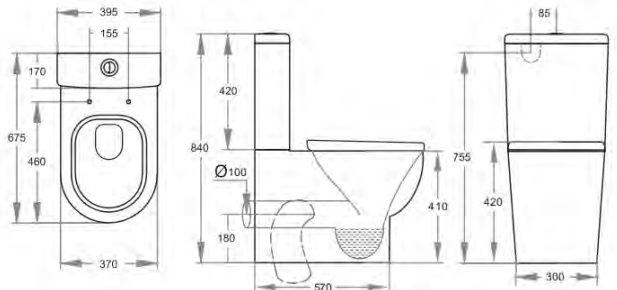

Mercury BTW Toilet Suite KDK014

\$396



Back/Left and Right Bottom Inlet Cistern (KDK014C)
Box Rim Pan (KDK014P)

Features

4.5/3 Liters Dual Flush

Size: **665*375*810mm**

Trap-60: 60-165mm (Supplied)

UF Standard Seat SC804 (Supplied)

Optional

Trap-100: 100-225mm

JT43: 150-260mm

P-Trap: 180mm

UF Slim Seat SC1064

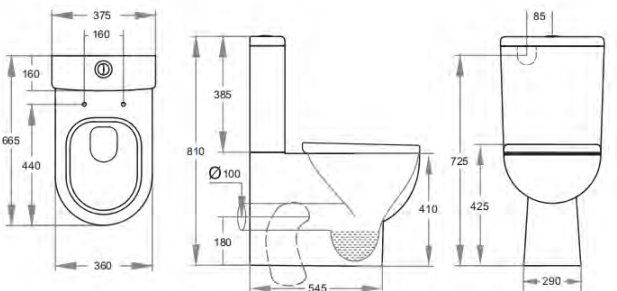

Box Rim Toilet Suite

Rio BTW Toilet Suite KDK013

\$319



Back/Left and Right Bottom Inlet Cistern (KDK013C)
Box Rim Pan (KDK013P)

Features

4.5/3 Liters Dual Flush
Size: **635*375*810mm**
Trap-60: 60-155mm (Supplied)
Standard PP Seat SC020 (Supplied)

Optional

Trap-100: 100-195mm
JT43 : 150-235mm
P-Trap: 180mm

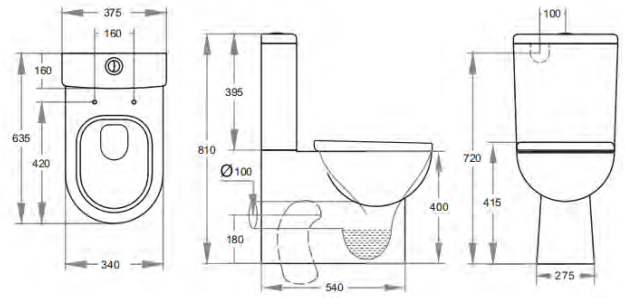

AS 1172.1
1172.2
WELS Reg No.
L03105



Theo BTW Toilet Suite KDK016

\$319



Back/Left and Right Bottom Inlet Cistern (KDK016C)
Box Rim Pan (KDK016P)

Features

4.5/3 Liters Dual Flush
Size: **660*375*845mm**
Trap-60: 60-155mm (Supplied)
Standard PP Seat SC010 (Supplied)

Optional

Trap-100: 100-205mm
JT43: 150-240mm
P-Trap: 180mm

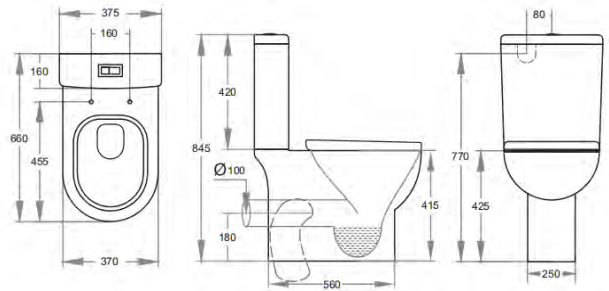

AS 1172.1
1172.2
WELS Reg No.
L03945



Closed Couple Toilet Suite

Cubo Closed Couple Toilet Suite KDK006

\$275



AS 1172.1
1172.2
WELS Reg No.
LO2580



Bottom Inlet Cistern (KDK006C)
Box Rim Pan (KDK006P)

Features

4.5/3 Liters Dual Flush
Size: **655*380*800mm**
Bottom Inlet Valve
S-Trap: 140mm
Soft Closing Seat SC011 (Supplied)

Optional
Back Inlet Valve

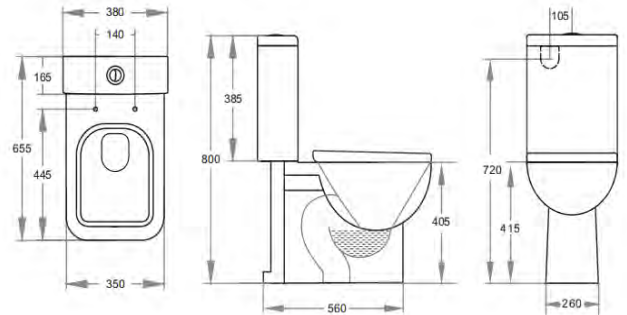

Zion Closed Couple Toilet Suite KDK009S

\$264



AS 1172.1
1172.2
WELS Reg No.
LO3100



Bottom Inlet Cistern (KDK009SC)
Box Rim Pan (KDK009SP)

Features

4.5/3 Liters Dual Flush
Size: **630*350*805mm**
Bottom Inlet Valve
S-Trap: 140mm
Soft Closing Seat SC392 (Supplied)

Optional
Back Inlet Valve

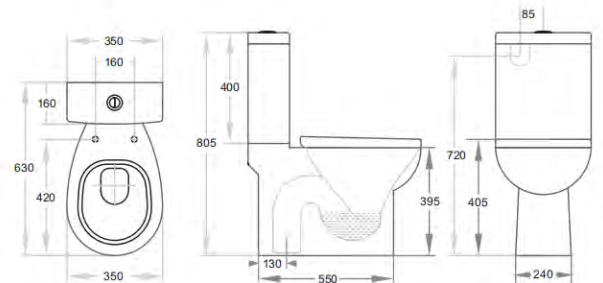

Wall Faced Pan

Rimless

Avis Rimless Wall Faced Floor Pan KDK102R Gloss White: \$495 Matte Black: \$770 Matte White: \$770



Features

4.5/3 Liters Dual Flush
 Size: **575*360*415mm**
 Trap-100: 100-135mm (Supplied)
 UF Slim Seat SC1064 (Supplied)

Optional

Trap-60: 60-80mm
 JT43: 150-170mm
 UF Standard Seat SC803

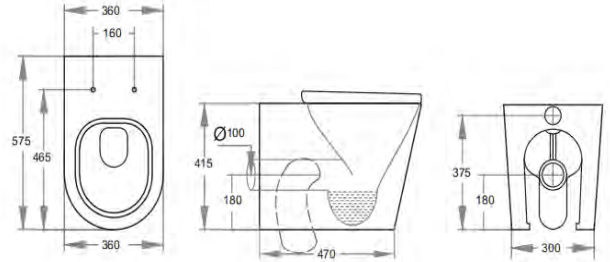

AS 1172.1
 1172.2
 WELS Reg No.
 L05610



Elvera Rimless Extra Height Wall Faced Floor Pan KDK107R

\$550



Features

Easy Height

4.5/3 Liters Dual Flush
 Size: **585*360*455mm**
 Trap-100: 100-130mm (Supplied)
 UF Standard Seat SC803 (Supplied)

Optional

Trap-60: 60-75mm
 JT43: 150-165mm

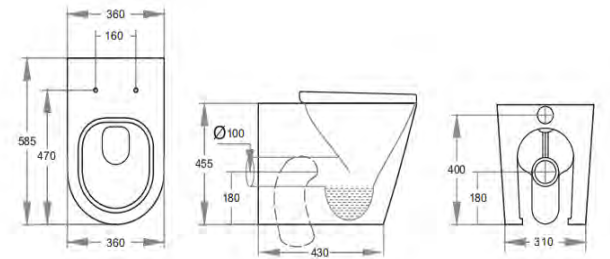

AS 1172.1
 1172.2
 WELS Reg No.
 L05611



Tornado

Veda Wall Faced Floor Pan KDK105T

Gloss White: \$473 Gloss Black: \$660



Features

Black and White Colors

4.5/3 Liters Dual Flush
 Size: **595*360*410mm**
 Trap-100: 100-115mm (Supplied)
 UF Slim Seat SC805 (Supplied)

Optional

Trap-60: 60mm
 JT43: 150mm
 UF Standard Seat SC804

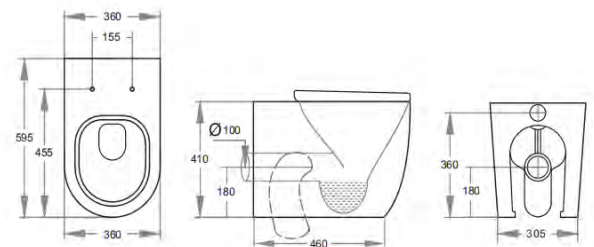

AS 1172.1
 1172.2
 WELS Reg No.
 L04965



Wall Faced Pan

Box Rim

Avery Wall Faced Floor Pan KDK102

Gloss White: \$385 Gloss Black: \$583



AS 1172.1
1172.2
WELS Reg No.
LO2582



Features

Black and White Colors

4.5/3 Liters Dual Flush

Size: **595*360*415mm**

Trap-60: 60-95mm (Supplied)

UF Standard Seat SC803 (Supplied)

Optional

Trap-100: 100-145mm

JT43: 150-185mm

P-Trap: 180mm

UF Slim Seat SC1064

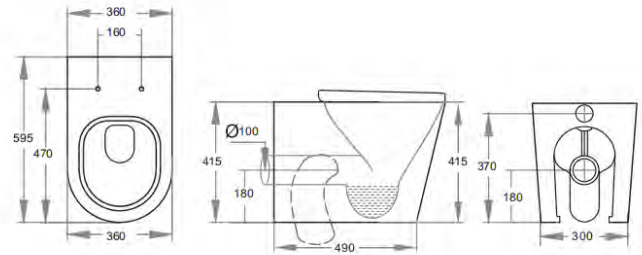

Qubist Wall Faced Floor Pan KDK103

Gloss White: \$385 Gloss Black: \$583



AS 1172.1
1172.2
WELS Reg No.
LO2583



Features

Black and White Colors

4.5/3 Liters Dual Flush

Size: **595*345*410mm**

UF Standard seat SC802 (Supplied)

Optional

Trap-60: 60-110mm

Trap-100: 100-160mm

JT43: 150-200mm

P-Trap: 180mm

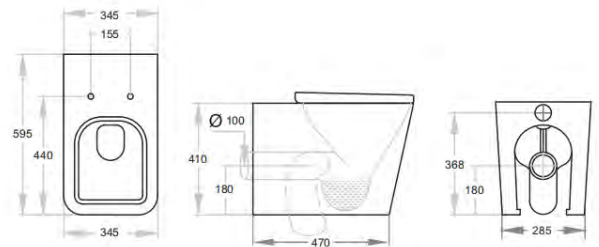

Wall Hung Pan

Rimless

Avis Rimless Wall Hung Pan KDK302R Gloss White: \$495 Ma e Black: \$770 Ma e White: \$770



Features
 4.5/3 Liters Dual Flush
 Size: **520*360*325mm**
 UF Slim Seat SC1064 (Supplied)

Optiona
 UF Standard Seat SC803

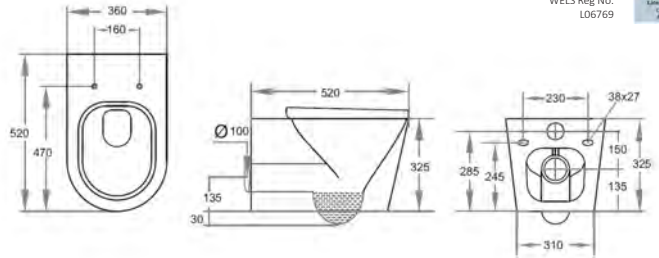

Veda Rimless Wall Hung Pan KDK305R Gloss White: \$495



Features
 4.5/3 Liters Dual Flush
 Size: **550*360*330mm**
 UF Slim Seat SC1064 (Supplied)

Optiona
 UF Standard Seat SC804

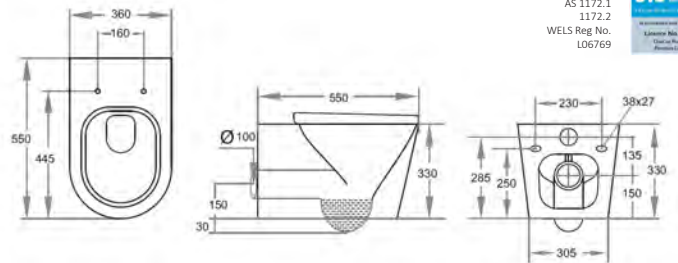

Box Rim

Avery Wall Hung Pan KDK302

Gloss White: \$385 Gloss Black: \$583



Features
 4.5/3 Liters Dual Flush
 Size: **555*360*320mm**
 UF Standard Seat SC804 (Supplied)

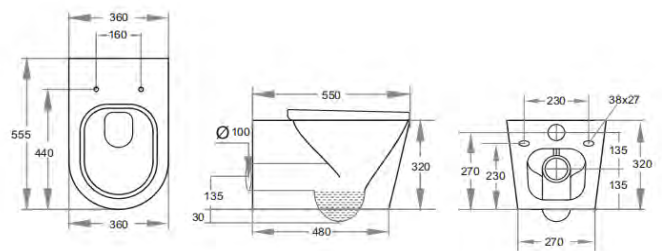

Qubist BTW Wall Hung Pan KDK303

Gloss White: \$385 Gloss Black: \$583



Features
 4.5/3 Liters Dual Flush
 Size: **550*340*320mm**
 UF Standard seat SC802 (Supplied)

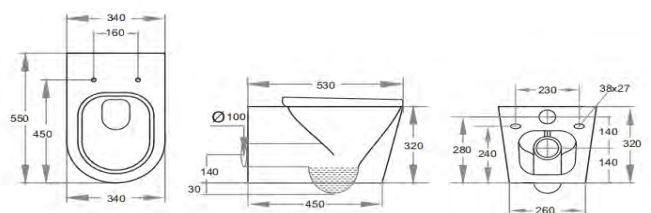

Bidet

Avery BTW Bidet KDK202

\$385



Size: 590*365*410mm

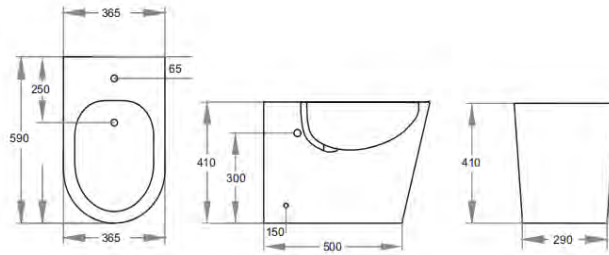

Qubist Bidet KDK203

\$385



Size: 595*355*410mm

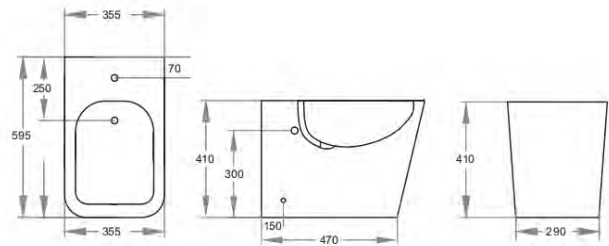

Veda BTW Bidet KDK205

\$385



Size: 590*360*410mm

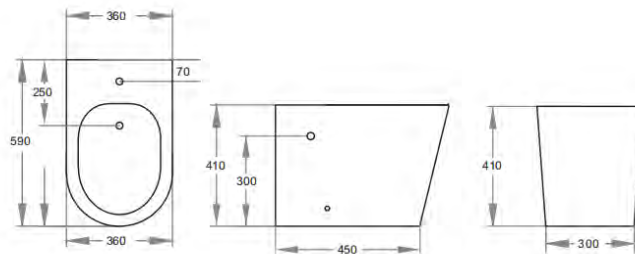

Bidet Accessories



PTS01 \$78

ABS Round Bidet Spray Wash Kit
With Diverter



PTS02 \$138

Brass Square Bidet Spray Wash Kit
With Diverter



Special Care Ambulant Toilet Suite

Amber Toilet Suite KDK019

\$506



Bottom Inlet Cistern (KDK019C/KDK009C)
Easy Height Raised Pan (KDK019P)

Features

4.5/3 Liters Dual Flush
Size: **630*350*875mm**
S-trap: 140mm
Soft Closing Seat PP017 (Supplied)

Optional

Change to Single Flap Care Seat SC807 when Back Rest is used.

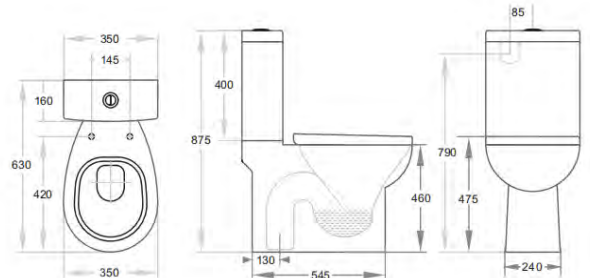

AS 1428.1-2009 Compliant

Ambulant Box Rim Toilet Suite KDK021

\$550



Back/Left and Right Bottom Inlet Cistern (KDK021C)
Box Rim Easy Height Raised Pan (KDK021P)

Features

4.5/3 Liters Dual Flush
Size: **660*400*905mm**
Trap-100: 100-185mm (Supplied)
UF Standard Seat SC803 (Supplied)

Optional

Trap-60: 60-135mm
JT43: 150-225mm
P-Trap: 180mm
Change to Single Flap Care Seat SC130 when Back Rest is used.

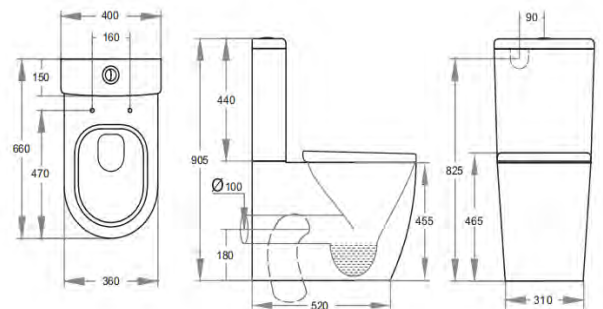

AS 1428.1-2009 Compliant

Elvera Ambulant Tornado Toilet Suite KDK027

\$660



Back/Left and Right Bottom Inlet Cistern (KDK027C)
Easy Height Raised Pan (KDK027P)

Features

4.5/3 Liters Dual Flush
Size: **650*385*870mm**
Trap-100: 100-140mm (Supplied)
UF Standard Seat SC803 (Supplied)

Optional

Trap-60: 60-90mm
JT43: 150-180mm
P-Trap: 180mm
UF Slim Seat SC074 (Supplied)
Change to Single Flap Care Seat SC130 when Back Rest is used.

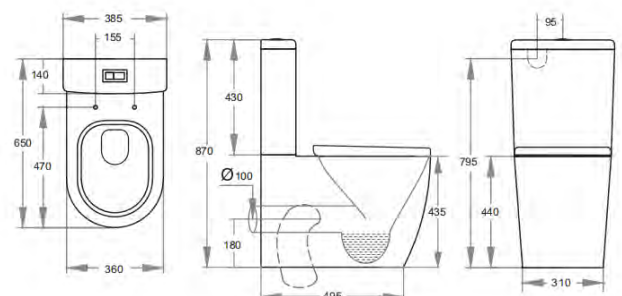

AS 1428.1-2009 Compliant



Special Care Disable Toilet Suite

Calla Disable Toilet Suite KDK024

\$636



Bottom inlet cistern (KDK024C)
Box Rim Pan (KDK024P)

Features

4.5/3 Liters Dual Flush
Size: **820*350*1180mm**
S-trap: 290mm (Supplied)
Single Flap Care Seat SC807 (Supplied)
Back Rest (Care-BR) Not Included

Optiona

Blue/Grey Seat Cover
Blue/Grey Press Button

AS 1428.1-2009 Compliant



AS 1172.1
1172.2
WELS Reg No.
L04966

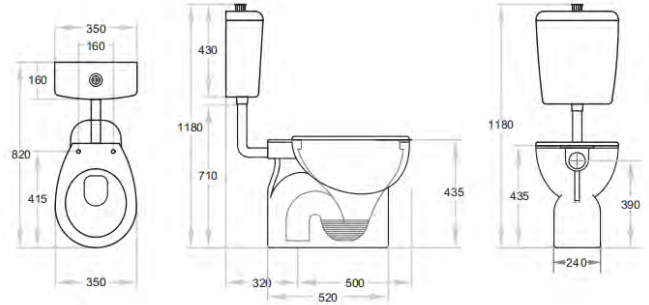

Calla Disable P-Trap Toilet Suite KDK029

\$636



Bottom inlet cistern (KDK029C)
Box Rim Pan (KDK029P)

Features

4.5/3 Liters Dual Flush
Size: **820*350*1180mm**
P-Trap (Supplied)
Single Flap Care Seat SC807 (Supplied)
Back Rest (Care-BR) Not Included

Optiona

Blue/Grey Seat Cover
Blue/Grey Press Button

AS 1428.1-2009 Compliant



AS 1172.1
1172.2
WELS Reg No.
L05613

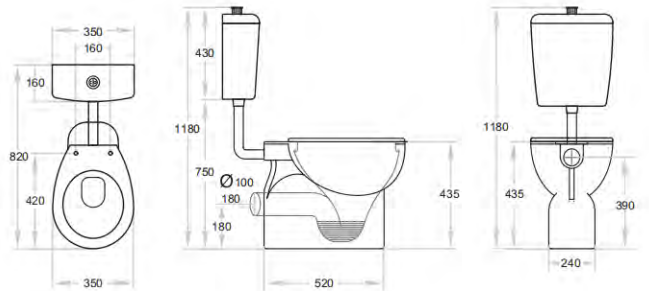

Asta Disable Rimless Toilet Suite KDK800

\$1,430



Back/Left and Right Bottom Inlet Cistern (KDK800C)
Rimless Flush Pan (KDK800P)

Features

4.5/3 Liters Dual Flush
Size: **805*375*890mm**
Trap-100: 180-325mm (Supplied)
Single Flap Care Seat SC130 (Supplied)

Optiona

Trap-60: 155-270mm
JT43: 230-365mm
P-Trap: 180mm

AS 1428.1-2009 Compliant



AS 1172.1
1172.2
WELS Reg No.
L05899

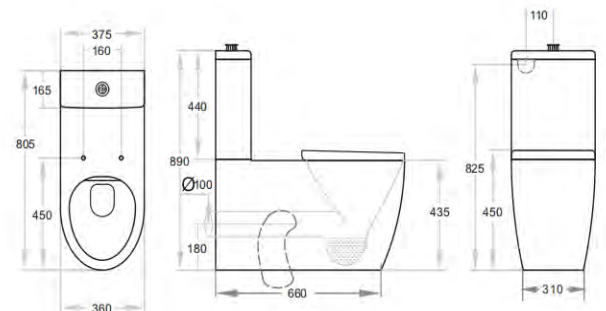

Special Care Wall Faced Pan

Asta Care Tornado Wall Faced Floor Pan KDK106

\$1,067



Features

Raised Height

4.5/3 Liters Dual Flush
 Size: **800*360*430mm**
 Trap-100: 160-290mm (Supplied)
 Single Flap Care Seat SC130 (Supplied)

Optional

Trap-60: 130-240mm
 JT43: 210-325mm
 P-Trap: 180mm

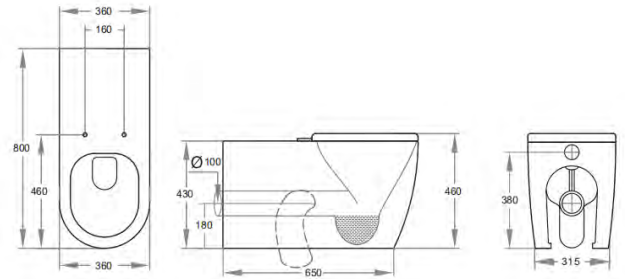

AS 1428.1-2009 Compliant

Avis Rimless Extra Height Wall Faced Floor Pan KDK102HR

\$550



Features

4.5/3 Liters Dual Flush
 Size: **620*360*440mm**
 Trap-100: 100-150mm (Supplied)
 UF Thick Seat SC803 (Supplied)

Optional

Trap-60: 60-90mm
 JT43: 150-180mm

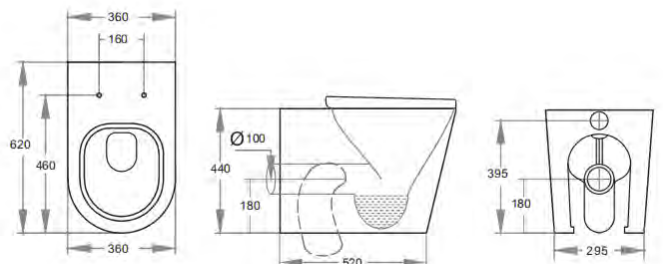

AS 1428.1-2009 Compliant

Elvera Tornado Wall Faced Floor Pan KDK107T

\$517



Features

Extra Height Raised Pan
 4.5/3 Liters Dual Flush
 Size: **630*365*445mm**
 Trap-100: 100-140mm (Supplied)
 UF Thick Seat SC803 (Supplied)

Optional

Trap-60: 60-90mm
 JT43: 150-195mm
 P-Trap: 180mm

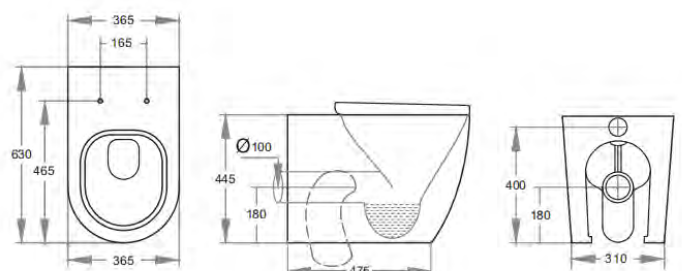

AS 1428.1-2009 Compliant



Special Care Junior Toilet Suite

Avis Junior Toilet Suite KDK600J

\$1,210



Back/Left and Right Bottom Inlet Cistern (KDK600JC)
Junior Wall Faced Toilet Suite Pan (KDK600JP)



Features
4.5/3 Liters Dual Flush
Size: **600*340*770mm**
Trap-60: 60-100mm (Supplied)
Standard Seat U4041 (Supplied)

Optional
Trap-100: 100-160mm
JT43: 150-190mm

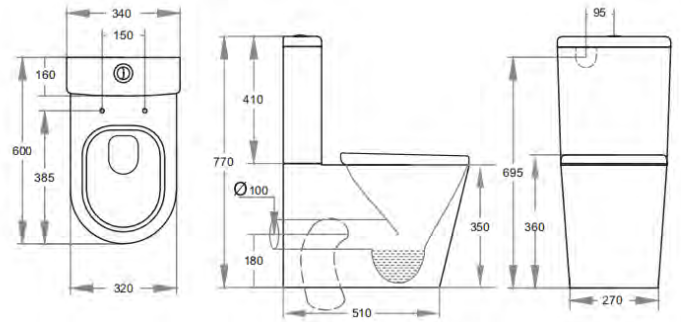

AS 1428.3-2009 Compliant

Special Care Toilet Parts



SC130 \$255

Seat Cover for KDK800, KDK106
Blue: SC130B
Grey: SC130G



SC807 \$255

Seat Cover for KDK024
Blue: SC807B
Grey: SC807G



Care-PB \$29

Press Button for Special Care Toilets
Blue: Care-PBB
Grey: Care-PBG



K07 \$66

Flush Pipe for KDK024



Care Accessories



Care-Grab Rail
32mm tubs
304 Grade Stainless Steel

Bradley Code

Care-GR400	832-001-16	400mm Stainless Steel	\$109
Care-GR450	832-001-18	450mm Stainless Steel	\$117
Care-GR500	832-001-20	500mm Stainless Steel	\$137
Care-GR750	832-001-30	750mm Stainless Steel	\$137
Care-GR800	832-001-32	800mm Stainless Steel	\$154
Care-GR1000	832-001-40	1000mm Stainless Steel	\$168
Care-GR1200	832-001-48	1200mm Stainless Steel	\$176
Care-GR1500	832-001-60	1500mm Stainless Steel	\$302

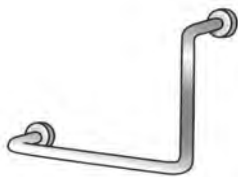

Care-M-GR4545 \$146
32mm Ambulant Grab Rail
90 Degree
Bradley Code: 832-006-AMB
450*450mm



Care-GR8770L \$264
32mm Toilet Grab Rail
40 Degrees Left Hand
Bradley Code: 832-1426
870*700mm



Care-GR8770R \$264
32mm Toilet Grab Rail
40 Degrees Right Hand
Bradley Code: 832-1427
870*700mm

MAP Care Accessories



Care-M-Grab Rail
32mm tubs

Bradley Code

Care-M-GR300	MAP-1011-12 (300mm)	\$58
Care-M-GR600	MAP-1011-24 (600mm)	\$69
Care-M-GR900	MAP-1011-36 (900mm)	\$86



Care-M-GR9560L \$183
32mm Toilet Grab Rail
90 Degree Left Hand
950*600mm



Care-M-GR9560R \$183
32mm Toilet Grab Rail
90 Degree Right Hand
950*600mm



Care-BR \$416
Care Back Rest
560mm W centers with 360mm wide
backrest



MAP Care Accessories



5123 \$207
Double Toilet Tissue Dispenser
324*162*51mm



5054 \$66
Toilet Tissue Dispenser
152*70*114mm



MAP-1003PT \$218
Paper Towel Holder
255*330*75mm



MAP-1005PH \$174
Paper Holder
270*270*114mm



MAP-1007 \$161
Horizontal Stainless Steel
Soap Dispenser
202*122*72mm



MAP-1008 \$161
Vertical Stainless Steel
Soap Dispenser
122*202*72mm



MAP-1006SH \$73
ABS Soap Dispenser
113*200*120mm



MAP-1010 \$460
Stainless Steel
Framed Mirror
450*1000mm

Disabled Shower Accessories



Care-SH01806C \$506
Hand-held Shower Kit
Suit 32mm Grab Rail



Care-GR6611C \$297
32mm Shower Grab Rail
660*1100mm Center



Care-GR6611L \$297
32mm Shower Grab Rail
660*1100mm Left Hand



MAP-GR6611R \$297
32mm Shower Grab Rail
660*1100mm Right Hand



MAP-1009 \$128
Stainless Steel Shower Shelf
350*125*95mm



MAP-Care-SC1017 \$753
Stainless Steel Shower Seat
970*357mm



Care-5400GRC \$99
Shower Holder
Attachment to 32mm Grab Rail



■ GEBERIT Sigma Push Button

Sigma20



Sigma20KJ \$182

115.882.KJ.1

White, Matte Chrome Trim
246*164mm



Sigma20KM \$218

115.882.KM.1

Black, Chrome Trim
246*164mm



Sigma20KH \$218

115.882.KH.1

Chrome, Matte Chrome Trim
246*164mm



Sigma20MBM \$212

115.882.16.1

Fingerprint Resistant,
Matte Black, Black Trim
246*164mm

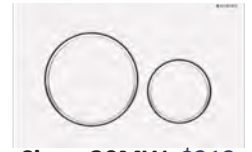

Sigma20MW \$212

115.882.01.1

Fingerprint Resistant,
Matte White, White Trim
246*164mm



Sigma20KK \$298

115.882.KK.1

White, Gold Trim
246*164mm



Sigma20SN \$410

115.882.SN.1

Stainless Steel, Chrome Trim
246*164mm



Sigma20JQ \$212

115.882.JQ.1

Fingerprint Resistant,
Matte Chrome, Chrome Trim
246*164mm



Sigma20MB \$212

115.882.14.1

Fingerprint Resistant,
Matte Black, Chrome Trim
246*164mm

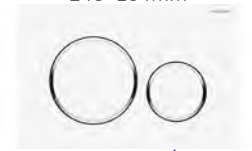

Sigma20JT \$212

115.882.JT.1

Fingerprint Resistant,
Matte White, Chrome Trim
246*164mm

Sigma30



Sigma30KJ \$156

115.883.KJ.1

White, Chrome Trim
246*164mm



Sigma30KM \$156

115.883.KM.1

Black, Chrome Trim
246*164mm



Sigma30KH \$178

115.883.KH.1

Chrome, Matte Chrome Trim
246*164mm



Sigma30MW \$178

115.883.01.1

Matte Finish, White Trim
246*164mm

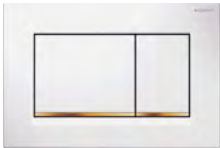

Sigma30KK \$178

115.883.KK.1

White, Gold Trim
246*164mm



Sigma30JQ \$178

115.883.JQ.1

Fingerprint Resistant, Matte
Finish, Chrome Trim
246*164mm

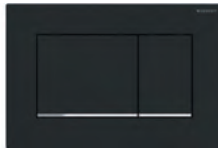

Sigma30MB \$178

115.883.14.1

Fingerprint Resistant, Matte
Black, Chrome Trim
246*164mm



Sigma30MBM \$178

115.883.16.1

Fingerprint Resistant,
Matte Black, Black Trim
246*164mm



Sigma30JT \$178

115.883.JT.1

Fingerprint Resistant,
Matte White, Chrome Trim
246*164mm

Sigma50



Sigma50KJ \$454

115.788.11.5

White Glass Plate, Brushed Chrome
246*164mm



Sigma50DW \$454

115.788.DW.5

Black Glass Plate, Brushed Chrome
246*164mm



Sigma50SD \$568

115.788.SD.5

Smoke Reflective Glass Plate, Brushed Chrome
246*164mm

Sigma60



Sigma60GH \$598

115.640.GH.1

Brushed Chrome, Chrome Trim
246*164mm



Sigma60SJ \$598

115.640.SJ.1

Black, Chrome Trim
246*164mm

Sigma21



Sigma21 \$598

115.884.00.1

Matte Black, Chrome Trim
246*164mm



Sigma21SJ \$444

115.884.SJ.1

Matte Black, Chrome Trim
246*164mm

■ GEBERIT Sigma Cistern Suite



Sigma8 \$575

109.795.00.1

Frame-less In-wall Cistern
For Wall Faced Floor Pan
- Mechanical Front Flush
- WELS 4 Star 4.5L/3L
- Made in Germany
- Match Wall Faced Floor Pan series

Sigma8 Package 1 \$1,056

Pan: White Box Rim
Wall Faced Floor Pan
KDK102/KDK103
Cistern: Sigma8
Bu on: Geberit ABS Bu on



Sigma8-F \$1,032

111.698.00.1

Frame In-wall Cistern
For Wall Hung Pan
- Mechanical Front Flush
- WELS 4 Star 4.5L/3L
- Made in Germany
- Match Wall Hung Pan series

Sigma8 Package 2 \$1,496

Pan: White Box Rim
Wall Faced Floor Pan
KDK302/KDK303
Cistern: Sigma8-F
Bu on: Geberit ABS Bu on

■ GEBERIT Kappa Push Button & Cistern Suite



Kappa21KH \$218

115.240.KH.1

Chrome, Ma e Chrome Trim
212*142mm



Kappa21KJ \$182

115.240.KJ.1

White, Chrome Trim
212*142mm



Kappa21KM \$218

115.240.KM.1

Black, Chrome Trim
212*142mm



Kappa21KK \$218

115.240.KK.1

White, Gold Trim
212*142mm



Kappa21KN \$218

115.240.KN.1

Ma e, Chrome Trim
212*142mm



Kappa \$575

110.208.00.1

Frame less In-wall Cistern
For Wall Faced Floor Pan
- For low height installation
- Front/Top Flush
- WELS 4 Star 4.5L/3L
- Made in Germany
- Match Wall Faced Floor Pan series



Kappa-F \$1,032

111.263.00.1

Frame In-wall Cistern
For Wall Hung Pan
- For smaller bathroom space, Each frame is tested to withstand 400kg of weight
- Front/Top Flush
- WELS 4 Star 4.5L/3L
- Made in Germany
- Match Wall Hung Pan series



Kappa Mid-Level \$575

Geberit Code:224.368.00.1

Frame less In-wall Cistern
For Wall Faced Floor Pan
- Fill the gap between Sigma and low-level Kappa Cisterns
- Variable bu on height
- Front/Top Flush
- WELS 4 Star 4.5L/3L
- Made in Germany

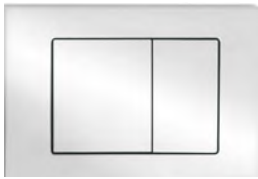

G3004109 \$120
Square Push Plate
Chrome



G3004109B \$145
Square Push Plate
Matte Black

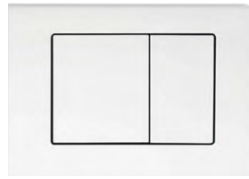

G3004109W \$165
Square Push Plate
White

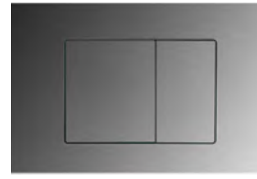

G3004109GM \$209
Square Push Plate
Gun Metal

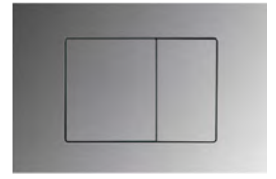

G3004109BN \$209
Square Push Plate
Brushed Nickel



G3004111 \$120
Round Push Plate
Chrome



G3004111B \$145
Round Push Plate
Black



G3004111W \$165
Round Push Plate
White



G3004111GM \$209
Round Push Plate
Gun Metal



G3004111BN \$209
Round Push Plate
Brushed Nickel

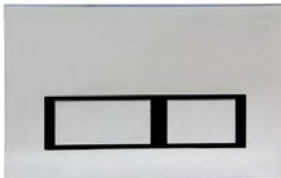

G3004112 \$120
Square Push Plate
Chrome



G3004112B \$145
Square Push Plate
Matte Black



G3004112W \$165
Square Push Plate
White



G3100003 \$198
Square Push Plate
Glass White



G30032 \$374
Frame-less In-Wall Cistern
For Wall Faced Pan

R&T Package 1 \$726
Pan: White Box Rim
Wall Faced Floor Pan
KDK102/KDK103
Cistern: G30032
Bu on: R&T ABS Bu on



G30031 \$572
Frame In-Wall Cistern
For Wall Hung Pan

R&T Package 2 \$990
Pan: White Box Rim Wall
Hung Pan KDK302/KDK303
Cistern: G30032
Bu on: R&T ABS Bu on

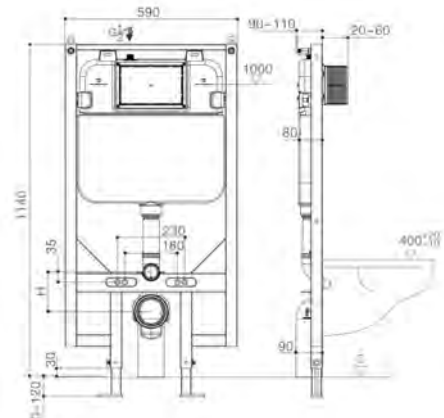
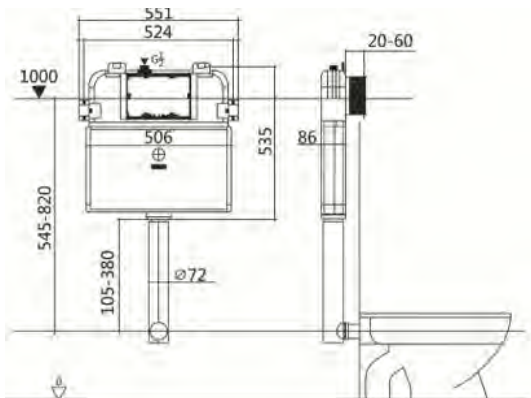



R&T In-Wall Cistern



G3005071 \$110

Round Push Plate Chrome
210*140mm



G3005071B \$143

Round Push Plate Black
210*140mm



G3005071W \$165

Round Push Plate White
210*140mm



G3005008 \$110

Square Push Plate Chrome
210*140mm



G3005008B \$143

Square Push Plate Black
210*140mm

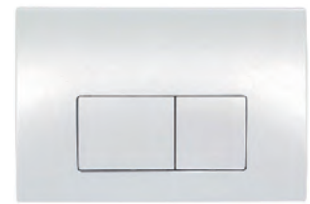

G3005008W \$165

Square Push Plate White
210*140mm



G3005 \$374

Frame-less Low Height In-Wall
Cistern for Wall Faced Pan



G3005-F \$616

Frame Low Height In-Wall
Cistern for Wall Hung Pan

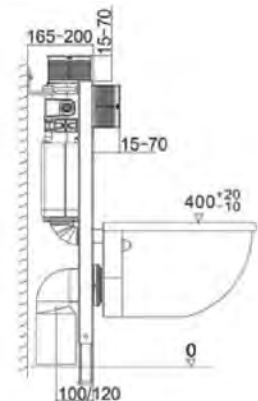
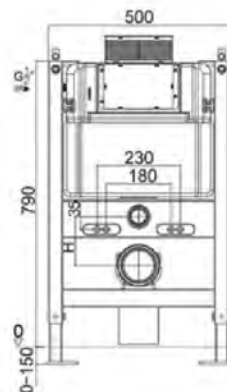
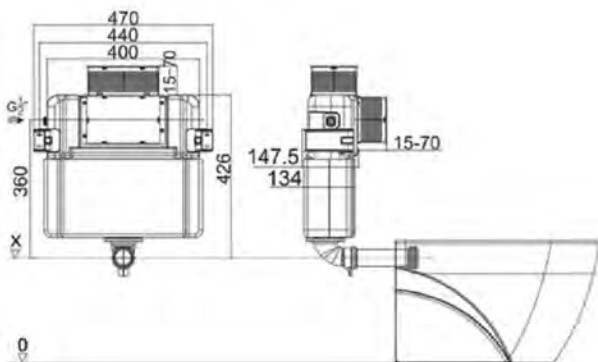

Seat Cover



SC802 \$99

Seat Cover for KDK003, KDK103,
KDK303
Gloss Black: SC802B \$176



SC803 \$99

Seat Cover for KDK002, KDK005, KDK008,
KDK026, KDK027,
KDK102, KDK102R, KDK102S,
KDK107R, KDK107T, KDK302R
Gloss Black: SC803B \$176
Matte Black: SC803-MB \$297
Matte White: SC803-MW \$297



SC804 \$99

Seat Cover for KDK018, KDK023, KDK025,
KDK022, KDK022R, KDK600, KDK102R,
KDK105, KDK105T, KDK302
Gloss Black: SC804B \$176
Matte Black: SC804-MB \$297
Matte White: SC804-MW \$297



SC805 \$121

Seat Cover for KDK022, KDK022R,
KDK023,025,600,105T,302,014,018



SC010 \$66

Seat Cover for KDK016



SC1064 \$121

Seat Cover for KDK002, 008,
016,021,022,022R,026,027,600,
102,102R,302R,107T,107R



SC017 \$66

Seat Cover for KDK009S,
KDK009P



SC011 \$66

Seat Cover for KDK006



SC020 \$66

Seat Cover for KDK013



U4041 \$255

Seat Cover for KDK600J



Spare Parts

In-wall Cistern Parts



RT001 \$42
R&T
Outlet Valve



RT002 \$42
R&T
Bottom Inlet Valve



RT003 \$55
R&T
Back Inlet Valve



RT004 \$18
Back Inlet Hose



RT005 \$8
R&T
Inlet Valve Hook



GB001 \$66
Geberit
Outlet Valve



GB002 \$66
Geberit
Bottom Inlet Valve



GB003 \$66
Geberit
Back Inlet Valve



K01 \$16
Wall Hung Toilet
Fixing Screw



K02 \$16
Cistern Fixing Screw



K04 \$16
Fixing Screw for SC010,
SC008, SC020



K05 \$16
Fixing Screw for SC802,
SC803, SC804



K05C-MB \$16
Hinge Cover
Matte Black



K06 \$16
Wall Hung Cistern
Screw for KDK024



K08 \$16
Nut for Universal Inlet



K10 \$16
Cistern Stop Plug



K11 \$16
Cistern Seal



K12 \$16
Bungs for Pan Holes



Spare Parts

R&T In-wall Cistern Parts



K13 \$59
In-wall Cistern
Plastic Screw



K14 \$30
In-wall Cistern
Inlet Pipe for G30031



K15 \$59
In-wall Cistern Thread
Fixture for G30031

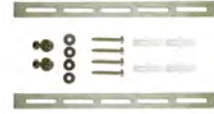

K16 \$61
In-wall Cistern
Plastic Brackets



K17 \$59
In-wall Cistern
Elbow



K18 \$30
In-wall Cistern
Inlet Pipe



K19 \$22
In-wall Cistern
Elbow Connector



K20 \$25
In-wall Cistern
Inlet Pipe Key Seal



K21 \$43
Frame In-wall Cistern
Outlet Trap

Press Button



PB-R
Chrome \$22



PB-RB
Black \$33



PB-RBN
Brushed Nickel \$40



PB-RMB
Matte Black \$40



PB-RMW
Matte White \$40



PB-RGM
Gum Metal \$40



PB-RBG
Brushed GOLD \$40



PB-S
Chrome \$22



PB-SB
BLACK \$33



PB-SBN
Brushed Nickel \$40



PB-SMB
Matte Black \$40



PB-SMW
Matte White \$40



PB-SGM
Gum Metal \$40



PB-SBG
Brushed GOLD \$40

Traps



Trap-60 \$61
S Trap



Trap-100 \$61
S Trap



K212 \$61
P Trap



JT43 Trap \$85
JT43 Trap

